

E721

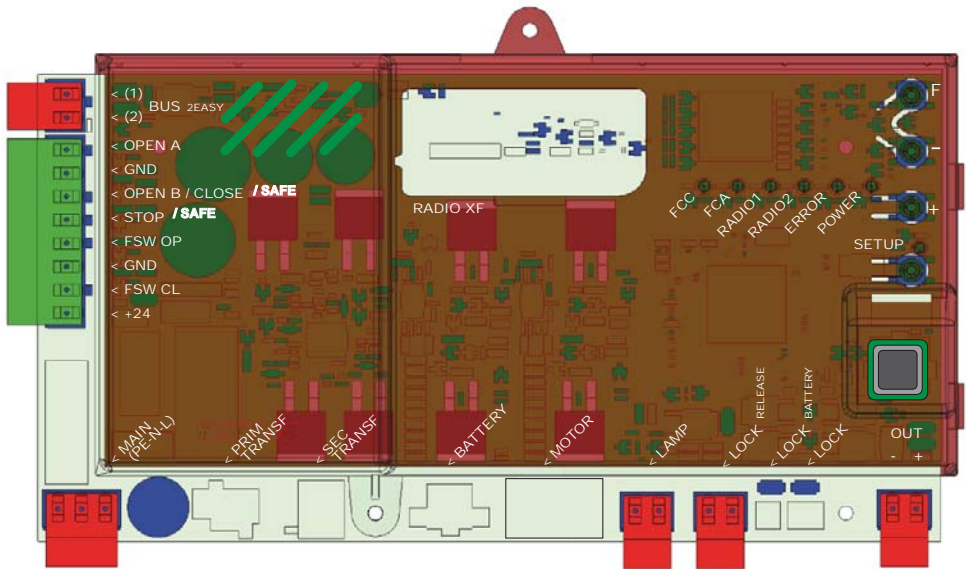

CONTENTS

1	WARNINGS.....	2
2	LAYOUT AND COMPONENTS.....	2
2.1	COMPONENT DESCRIPTION	3
2.2	DESCRIPTION OF TERMINAL BLOCK J13.....	3
3	TECHNICAL SPECIFICATIONS	3
4	ELECTRIC CONNECTIONS.....	4
4.1	BUS-2EASY PHOTOCELLS.....	5
4.1.1	ADDRESSING BUS-2EASY PHOTOCELLS	5
4.1.2	STORING BUS-2EASY ACCESSORIES	5
4.2	TRADITIONAL PHOTOCELLS.....	6
4.3	SAFE INPUT CONNECTIONS.....	7
5	PROGRAMMING	8
5.1	1 st LEVEL PROGRAMMING	8
5.2	2 nd LEVEL PROGRAMMING	10
6	STORING RADIO CODE	12
6.1	STORING DS RADIOCONTROLS	12
6.2	STORING SLH RADIOCONTROLS	13
6.3	STORING LC/RC RADIOCONTROLS (ONLY FOR SOME MARKETS)	13
6.3.1	STORING LC/RC RADIOCONTROLS REMOTELY	13
6.4	RADIOCONTROLS DELETION PROCEDURE	13
7	OPERATIONAL START-UP	14
7.1	CHECKING THE LEDS	14
7.2	BATTERY OPERATION	14
7.3	POSITIONING LIMIT SWITCHES	14
7.4	MASTER / SLAVE CONFIGURATIONS.....	16
7.4.1	MASTER / SLAVE WIRING	16
7.4.2	MASTER/SLAVE SETUP PROCEDURE.....	16
7.5	SETUP.....	17
8	TESTING THE AUTOMATED SYSTEM.....	17
9	ALARM AND ERROR SIGNALS.....	17
9.1	ALARMS.....	17
9.2	ERRORS	17
10	FUNCTION LOGICS	18

CE DECLARATION OF CONFORMITY

Manufacturer: FAAC S.p.A.

Address: Via Calari, 10 - 40069 Zola Predosa BOLOGNA - ITALY

Declares that: Control board E721

- conforms to the essential safety requirements of the following EEC directives
2006/95/EC Low Voltage Directive
2004/108/EC Electromagnetic Compatibility Directive

Additional note:



This product has undergone testing in a typical standard configuration (all products built by FAAC S.p.A.)

Bologna, 01-12-2010

The Managing Director
A. Marcellan







WARNINGS

- Attention! To ensure the safety of people, it is important that you read all the following instructions.
- Incorrect installation or incorrect use of the product could cause serious harm to people.
- Carefully read the instructions before beginning to install the product and keep for future reference.
- The symbol  highlights notes that are important for personal safety and the protection of the automated system.
- The symbol  calls your attention to notes on product specifications or operation.

E721

1 WARNINGS

-  Before attempting any work on the control board (connections, maintenance), always turn off power.
-  Install, upstream of the system, a differential thermal breaker with adequate tripping threshold.
-  Connect the earth lead to the appropriate terminal.
-  Always separate power cables from control and safety cables (push-button, receiver, photocells, etc.). To avoid any electric noise, use separate sheaths or a shielded cable (with earthed shield).

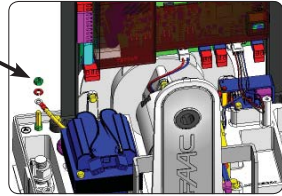

ENGLISH

2 LAYOUT AND COMPONENTS

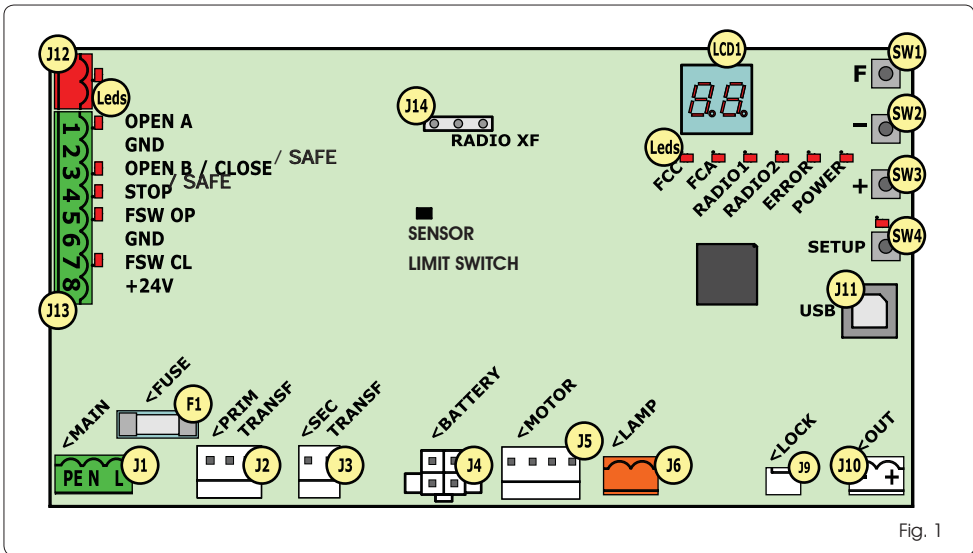

Fig. 1

2.1 COMPONENT DESCRIPTION

LCD	SIGNALLING AND PROGRAMMING DISPLAY
SW1	PROGRAMMING PUSH-BUTTON "F".
SW2	PROGRAMMING PUSH-BUTTON "-".
SW3	PROGRAMMING PUSH-BUTTON "+".
SW4	"SETUP" PUSH-BUTTON
LEDs	INPUTS STATUS CONTROL LED
J1	MAIN POWER SUPPLY CONNECTOR
J2	TRANSFORMER PRIMARY WINDING CONNECTOR
J3	TRANSFORMER SECONDARY WINDING CONNECTOR
J4	EMERGENCY BATTERY CONNECTOR (ACCESSORY)
J5	MOTOR CONNECTOR
J6	FLASHING LAMP CONNECTOR (24 V= - 15W)
J9	MOTOR LOCK AND MOTOR RELEASE CONTACT CONNECTOR
J10	OUT OUTPUT CONNECTOR
J11	USB CONNECTOR FOR PC CONNECTION
J12	BUS-2EASY DEVICE CONNECTION CONNECTOR
J13	INPUT CONNECTOR IN CONNECTOR BLOCK
J14	RADIO RECEIVER MODULE CONNECTOR FOR OMNIDECA
LCD1	SIGNALLING AND PROGRAMMING DISPLAY
F1	PROTECTION FUSE

2.2 DESCRIPTION OF TERMINAL BLOCK J13

INPUT	No	DESCRIPTION
1	OPEN A	Device with N.O. contact that causes total opening of the gate
2-6	GND	Accessory power supply negative
3(1)	OPEN B (DEFAULT)	Device with N.O. contact that causes partial opening of the gate
	CLOSE	Device with N.O. contact that closes the gate
	SAFE	Device with N.C. contact that causes the immediate and complete reversal of the gate
4(1)	STOP (DEFAULT)	Device with N.C. contact that halts the gate
	SAFE	Device with N.C. contact that causes the immediate and complete reversal of the gate
5	FSW OP	Device with N.C contact that reverses the motion during gate opening
7	FSW CL	Device with N.C contact that reverses the motion during gate closing
8	+ 24 V=	Accessory power supply positive

3 TECHNICAL SPECIFICATIONS

Power supply	230 V~ 50 Hz
Power consumption from mains stand-by	10 W
Motor max. load	10A
Accessory power supply	24 V=
Accessory max. current	24 V= max. 500 mA BUS-2EASY max. 500 mA
Environmental temperature	(-20 - +55) °C
Flashing lamp load	24 V= - 15 W
Output load	24 V= - 100 mA (2)
Protection fuses	F1 = T1A - 250V~
Function logics	Semiautomatic, Semiautomatic "step", Automatic, Automatic "step", Automatic with timer function, Automatic Safety devices, Automatic Safety devices "step", Automatic with reverse on pause, Semiautomatic "b", Mixed logic "bC", Dead-man.
Work time	Programmable (from 0 to 10 min.)
Pause time OPEN A / OPEN B	Programmable (from 0 to 10 min.)
Motor power	Adjustable over 50 levels
Opening-closing motor speed	Adjustable over 10 levels
Connector Inputs/Outputs	Power supply, Battery, Motor, Module XF433/868, Motor lock electric release batteries, Motor Lock, USB
Inputs/Outputs in terminal block	BUS-2EASY, OPEN A, OPEN B/CLOSE/SAFE, STOP/SAFE, GND, Opening and closing photocells, +24 V=, Mains power supply, Flasher, Electric release motor lock, OUT
Programming	1 st and 2 nd level with 3 keys (+, -, F) and display.

 (1) The uses of inputs 3 and 4 can be set by configuring the corresponding parameters at programming level 2 (parameters **Ob** and **SP**). For the exact description on how to operate the automated system with the chosen logics, please refer to the tables featured at the end of this manual (Par. 10 - OPERATION LOGICS. As for the wiring required using these SAFE configured inputs, please refer to the diagrams shown in Fig. 13 and Fig. 14

 (2) The output load must be considered as already included in the max. current available for the accessories

4 ELECTRIC CONNECTIONS

The wiring shown in Fig. 2 refers to the inputs of the board with DEFAULT configuration.

ENGLISH

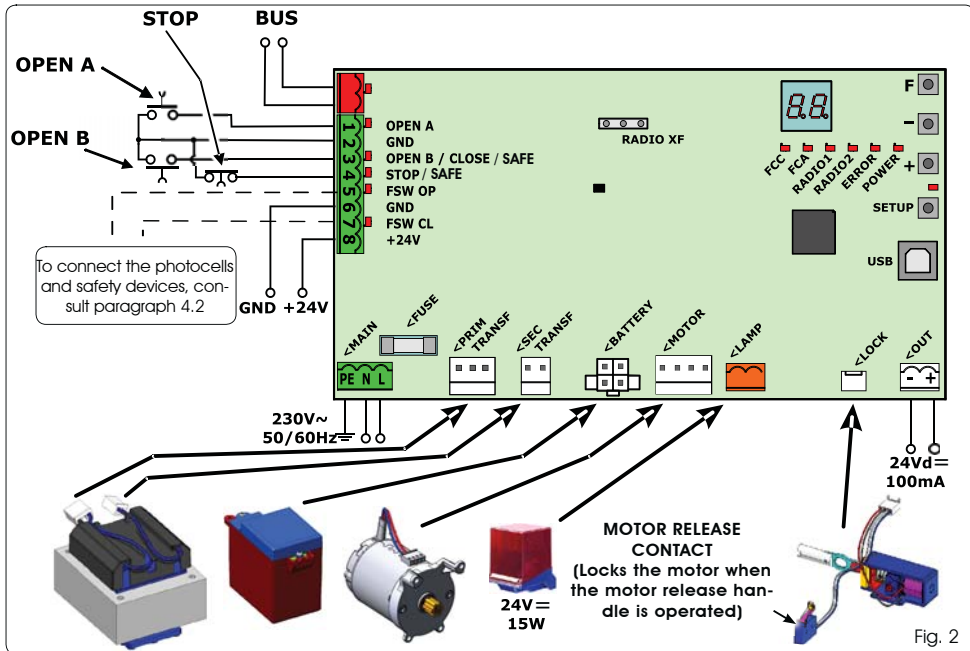

Fig. 2

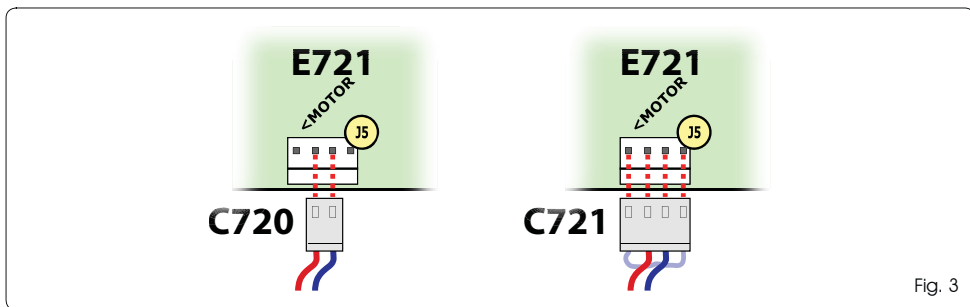

Fig. 3

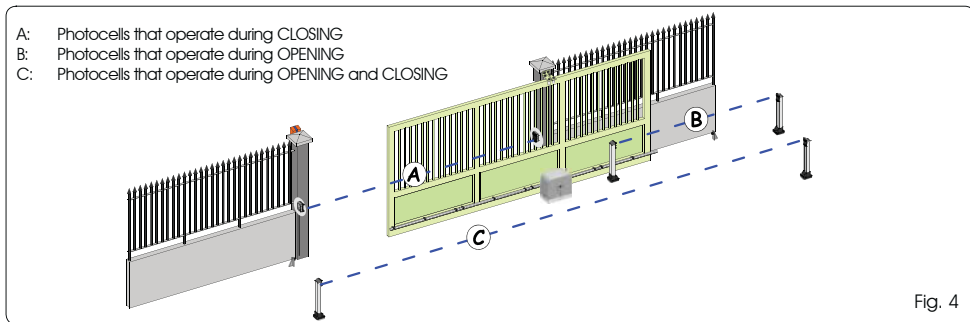

Fig. 4

Before connecting the photocells, it is advisable to select the type of operation on the basis of the area of movement that they need to protect:

Safety devices during closing: operate only during the automated system closing movement and are therefore suitable for protecting the closing area from the risk of impact.

Safety devices during opening: operate only during the automated system opening movement and are therefore suitable for protecting the opening area from the risk of impact.

Safety devices during opening/closing: operate during both the automated system opening and closing movements and are therefore suitable for protecting the entire movement area from the risk of impact.

4.1 BUS-2EASY PHOTOCELLS

This board is equipped with a BUS-2EASY circuit that can be used to easily connect a high number of auxiliary BUS-2EASY devices to the safety device (e.g. up to 16 pairs of photocells), appropriately programmed, using only two cables without polarity.

Before connecting the photocells, it is advisable to select the type of operation (Fig. 4) on the basis of the area of movement the cells must protect and to position the dip switches on both the transmitter and receiver (see Fig. 5) as in Tab. 1.

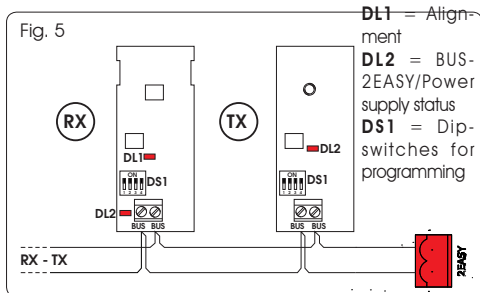

4.1.1 ADDRESSING BUS-2EASY PHOTOCELLS

It is important to give both the transmitter and the receiver the same address.

Ensure that there are not two or more photocell pairs with the same address.

If no BUS-2EASY accessory is used, leave the BUS-2EASY connector (J12 - fig. 1) free.

Tab. 1 - Addressing BUS-2EASY photocells

Dip1	Dip2	Dip3	Dip4	Re.	Type
OFF	OFF	OFF	OFF	B	OPENING Max. 6 pairs
OFF	OFF	OFF	ON		
OFF	OFF	ON	OFF		
OFF	OFF	ON	ON		
OFF	ON	ON	OFF		
OFF	ON	ON	ON		
ON	OFF	OFF	OFF	A	CLOSING Max. 7 pairs
ON	OFF	OFF	ON		
ON	OFF	ON	OFF		
ON	OFF	ON	ON		
ON	ON	OFF	OFF		
ON	ON	OFF	ON		
ON	ON	ON	OFF	C	OPENING and CLOSING Max. 2 pairs
OFF	ON	OFF	OFF		
OFF	ON	OFF	ON		
ON	ON	ON	ON	/	OPEN PULSE

4.1.2 STORING BUS-2EASY ACCESSORIES

At any time it is possible to add BUS-2EASY photocells and accessories to the system, simply by following the procedure below:

1. Install and programme the accessories with the required address (see par. 4.1.1).
2. Cut off power to the board.
3. Connect both cables of the BUS-2EASY accessories to the red terminal block J12 (polarity irrelevant).
4. Power the board.
5. Quickly press the SETUP push-button (SW4) once to register the accessories. Check the operation of the installed BUS-2EASY devices.
6. The board has stored the BUS-2EASY accessories.

Follow the instructions in the following table to check that the BUS-2EASY connection status is efficient.

The same procedure must be performed on a MASTER unit also when acquiring a SLAVE unit connected to the BUS-2EASY with POLARISED connection

Tab. 2 - Description of BUS-2EASY LED

Fixed ON	Normal activity (LED on even without photocells). No registered photocell engaged.
Slow flasher	At least one registered photocell engaged or not aligned.
Off (flash every 2.5 secs)	BUS-2EASY line short-circuited.
Off	- BUS-2EASY line disabled (does not supply power) - Battery operation - Unit programmed as a SLAVE

4.2 TRADITIONAL PHOTOCELLS

Connection of 1 pair of closing photocells with FAIL-SAFE safety device **activated**
 Set in **second level of programming**

01 = 01

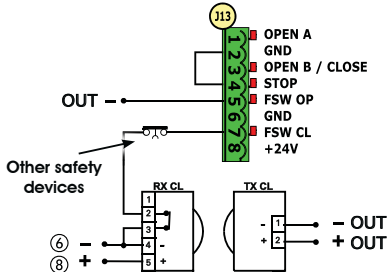

Connection of 1 pair of closing photocells with FAIL-SAFE and STOP safety device **deactivated**

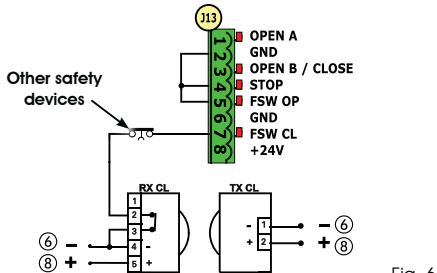

Fig. 6

If the FAIL-SAFE safety device is **not** used, connect the power supply of the transmitters to terminals 6 and 8 of J13.

If the FAIL-SAFE safety device is used, connect the power supply of the transmitters to OUT after setting it as appropriate (see 2nd level programming and Fig. 6).

If the FAIL-SAFE safety device is used, even the unused safety inputs must be connected via a shunt lead to the negative of OUT (see Fig. 6).

Connection of a pair of opening photocells

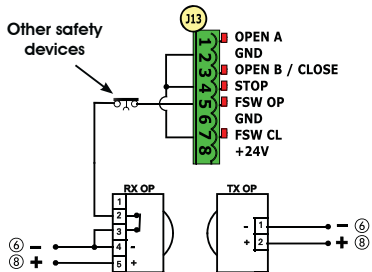

Fig. 7

Connection of a pair of closing photocells and a pair of opening photocells

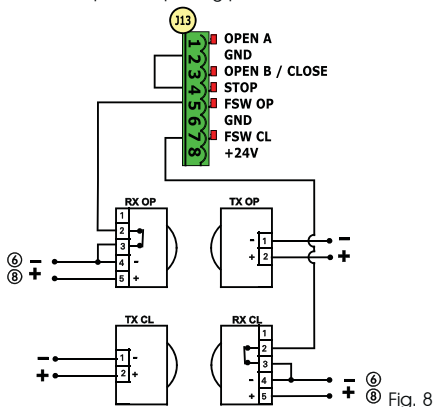

Fig. 8

Connection of two pairs of closing photocells

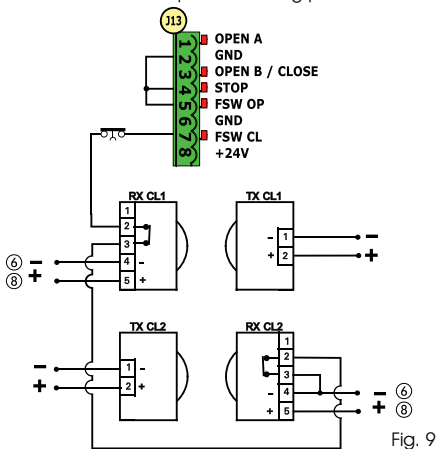

Fig. 9

Connection of a pair of closing photocells and a pair of opening/closing photocells

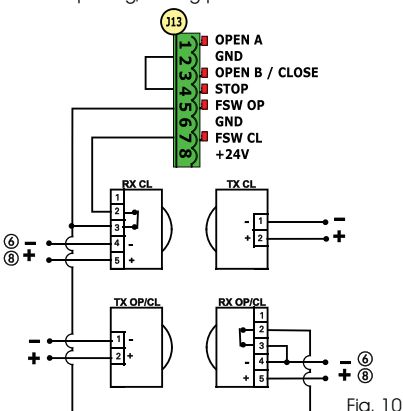

Fig. 10

Connection of a pair of closing photocells, a pair of opening photocells and a pair of opening/closing photocells

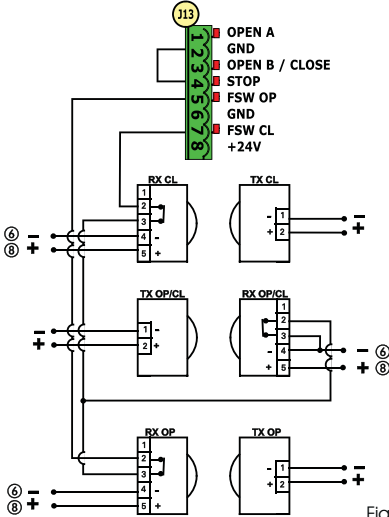

Fig. 11

Connection of no safety and stop device

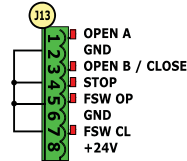

Fig. 12

4.3 SAFE INPUT CONNECTIONS

If the Fail Safe safety device is enabled (parameter that can be set in programming level 2), the negative used for managing the SAFE input is - OUT (see Fig. 13).

Connection of a safety device (other safety devices) to the SAFE input with the **FAIL SAFE** function enabled

By setting: 2nd level $\alpha 1=01$ (FAIL SAFE ENABLED)
2nd level $SP=01$ (INPUT 4 = SAFETY EDGE SAFETY)

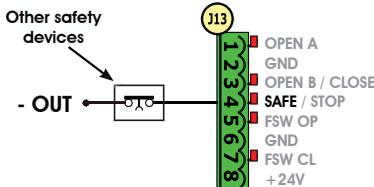

By setting: 2nd level $\alpha 1=01$ (FAIL SAFE ENABLED)
2nd level $Ob=02$ (INPUT 3 = SAFETY EDGE SAFETY)

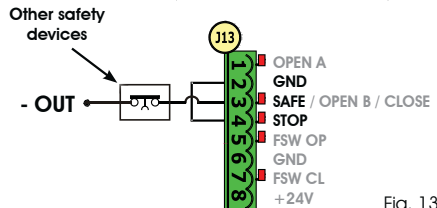
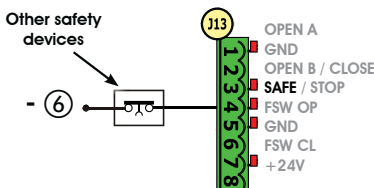

Fig. 13

If the Fail Safe safety device is disabled (parameter that can be set in programming level 2), the negative used for managing the SAFE input is - 6 (see Fig. 14).

Connection of a safety device (other safety devices) to the SAFE input with the **FAIL SAFE** function disabled

By setting: 2nd level $\alpha 1=00$ (FAIL SAFE DISABLED)
2nd level $SP=01$ (INPUT 4 = SAFETY EDGE SAFETY)



By setting: 2nd level $\alpha 1=00$ (FAIL SAFE DISABLED)
2nd level $Ob=02$ (INPUT 3 = SAFETY EDGE SAFETY)

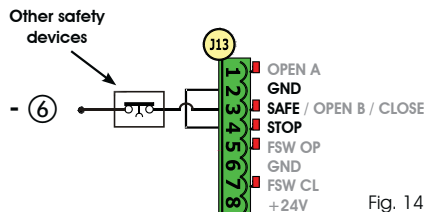



Fig. 14

In case N.C. contact devices are not used (other safety devices) the SAFE input must be jumpered to -OUT with FAIL SAFE enabled or to GND with FAIL SAFE disabled.

5 PROGRAMMING

It is necessary to access PROGRAMMING mode in order to program automated system operation.

Programming is divided in two parts: 1st LEVEL and 2nd LEVEL.

 **The status of the automated system is normally shown on the display. When push-button F is pressed or when F and + are pressed simultaneously, this gives access to 1st or 2nd level programming. During battery operation the display is off. Briefly press "+" to view the state of the automated system.**

 **To restore the default settings, simply reload the desired default in the first passage of the 1st level programming.**

5.1 1st LEVEL PROGRAMMING





To access 1st level programming, press push-button F.





- Press **F** (and hold down) to display the function name.
- If you release the key, the display shows the value of the function that can be modified with keys + and -.
- If you press **F** again (and hold it down), the display shows the name of the next function, etc.
- When you reach the last function, press push-button **F** to exit the program and store the parameters. The display shows again the status of the automated system.

 **Changes to the programming parameters become effective as soon as they are carried out, while final memorisation occurs only upon exiting programming and returning to the input state display. If the unit is powered down before returning to the input state display, all changes made will be lost.**

 **It is possible to return to the input status display and store all the parameters modified to that moment from any point of the 1st and 2nd level programming by pressing keys F and - simultaneously.**

 **When the board is turned on, the software version of the board with two figures separated by a decimal point appears on the LCD1 display.**



1 st LEVEL PROGRAMMING 		
Display	Function	Default
df	<p>DEFAULT:</p> <p>I Configures the parameters with DEFAULT values.</p> <p>CU If push-button F is released, the value CU appears, this means that the standard modified configuration has been selected by means of push-buttons and display. If you wish to maintain this programming, press push-button F again, otherwise press + and select default I.</p>	I
ct	<p>MASTER/SLAVE CONFIGURATION:</p> <p>MA Configures the board in MASTER mode</p> <p>SL Configures the board in SLAVE mode</p> <p> Configuring the board in SLAVE mode you will not be able to view the parameters LO-PA-Pb-PH-Qp (for Master/Slave operation see Par. 7.4)</p>	MA
LO	<p>FUNCTION LOGICS:</p> <p>E Semiautomatic.</p> <p>EP Semiautomatic "Step".</p> <p>A Automatic.</p> <p>A1 Automatic 1.</p> <p>AP Automatic "Step".</p> <p>At Automatic with timer function.</p> <p>SP Automatic "Safety devices".</p> <p>SP Automatic Safety Devices "Step".</p> <p>SA Automatic with reverse during pause.</p> <p>b Semiautomatic "b".</p> <p>C Mixed (AP pulse/ CH dead-man).</p> <p>C Dead-man.</p> <p> Parameter not displayed in SLAVE mode</p>	E
PA	<p>PAUSE TIME A:</p> <p>Pause time with a TOTAL opening command. This has effect only if the automatic logic was selected. Adjustable from 0 to 59 secs. in one-second steps. Subsequently, display changes to minutes and tens of seconds (separated by a point) and time is adjusted in 10-second steps, up to the maximum value of 9.5 minutes.</p> <p>E.g. if the display shows 2.5, pause time is 2 min. and 50 secs.</p> <p> Parameter not displayed in SLAVE mode</p>	20



Display	Function	Default
Pb	<p>PAUSE TIME B: Pause time with a PARTIAL opening command. This has effect only if the automatic logic was selected. Adjustable from 0 to 59 secs. in one-second steps. Subsequently, display changes to minutes and tens of seconds (separated by a point) and time is adjusted in 10-second steps, up to the maximum value of 9.5 minutes. E.g. if the display shows 2.5, pause time is 2 min. and 50 secs..</p> <p> Parameter not displayed in SLAVE mode</p>	20
FQ	<p>MOTOR POWER: Adjusts the motor power level</p> <p>01 = minimum power 50 = maximum power</p> <p> When the power value has been changed, it is advisable to perform a new SETUP (see par. 7.3)</p>	50
So	<p>OPENING SPEED: Adjusts the motor opening speed to 10 levels</p> <p>01 = minimum speed 10 = maximum speed</p> <p> When the speed value has been changed, it is advisable to perform a new SETUP (see par. 7.3)</p>	08
Sc	<p>CLOSING SPEED: Adjusts the motor closing speed to 10 levels.</p> <p>01 = minimum speed 10 = maximum speed</p> <p> When the speed value has been changed, it is advisable to perform a new SETUP (see par. 7.3)</p>	08
ro	<p>SLOWING DURING OPENING Adjusts the slowing space as a percentage of the total gate travel. Adjustable from 5 (with speed <5), 10 (with speed between 5 and 8), 15 (with speed >8) to 99 % in 1% steps.</p> <p>5-10-15 = minimum slowing 99 = maximum slowing</p>	20
rc	<p>SLOWING DURING CLOSING: Adjusts the slowing space as a percentage of the total gate travel. Adjustable from 5 (with speed <5), 10 (with speed between 5 and 8), 15 (with speed >8) to 99 % in 1% steps.</p> <p>5-10-15 = minimum slowing 99 = maximum slowing</p>	20
Sr	<p>SPEED DURING SLOWING: Adjusts gate speed during slowing.</p> <p>0 = LOW speed 1 = HIGH speed</p>	0
St	<p>STATUS OF AUTOMATED SYSTEM: Exit from programming, data storage, and return to gate status display.</p> <p>00 = CLOSED 01 = OPEN 02 = Stop then "OPEN" 03 = Stop then "CLOSE" 04 = In "PAUSE" 05 = During opening stage 06 = During closing stage</p> <p>07 = FAIL SAFE in progress 08 = BUS-2EASY device check in progress 09 = Preflashing then "OPEN" 10 = Preflashing then "CLOSE" 11 = OPEN in Partial Opening 12 = in PAUSE Partial Opening</p>	

5.2 2nd LEVEL PROGRAMMING

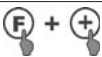
To access 2ND LEVEL PROGRAMMING, press push-button **F** and hold down while pressing push-button **+**:

- if you also release push-button **F**, the display shows the value of the function that can be modified with keys **+** and **-**.
- if you press key **F** (and hold down), the display shows the name of the next function. If you release it, the value that can be modified with keys **+** and **-** is displayed.
- when you reach the last function, press **F** to exit programming, and the display resumes showing the automated system status.

2 nd LEVEL PROGRAMMING 		
Display	Function	Default
bo	MAXIMUM TAKE-OFF POWER: The motor works at maximum power (ignoring the selected power level) during the movement take-off. y = active no = excluded	no
PF	PREFLASHING: Allows 5 types of preflashing to be selected, with a duration equal to 3 secs. no = no preflashing. OC = preflashing before each movement. CL = preflashing before a closing movement. OP = preflashing before an opening movement. PA = preflashing only at end of pause.	no
TP	PREFLASHING TIME (visible only if preflashing is selected in the previous menu): Adjusts preflashing time from 1 to 10 sec. in 1 second steps. 01 = minimum preflashing 10 = maximum preflashing	03
Ph	CLOSING PHOTOCELLS: Activate the function if you want the closing photocells to lock movement and reverse it on disengagement. Normally, operation of the closing photocells immediately puts the gate into reverse when this function is off. y = reversal on disengagement no = immediate reversal to opening.  Parameter not displayed in SLAVE mode	no
OP	OPENING PHOTOCELLS: Activate the function if you want the opening photocells to lock movement and reverse it during closing. Normally, with this function off, operation of the opening photocells determines the resumption of movement on their disengagement. no = immediate reversal to closing no = resumption of motion on disengagement  Parameter not displayed in SLAVE mode	no
Ad	ADMAMP FUNCTION Permits activation of operation in accordance with French standard NFP 25/362. y = active no = excluded	no
EC	ENCODER: The "virtual" encoder on the board operates as an anti-crushing device and manages the slowing and partial opening start points. If the gate strikes an obstacle during the opening or closing stage, the "virtual" encoder causes reversal of the motion. The second obstacle detected in the same direction causes the motor to stop. An alarm is signalled in both cases (see section on alarms). It is necessary to adjust the sensitivity of the "virtual" encoder by varying the time that the board waits for before controlling reversal of motion from a minimum of 0 sec to a maximum of 10 sec in one-second steps. 00 = maximum sensitivity 10 = minimum sensitivity	02

Display	Function	Default
P0	PARTIAL OPENING: It is possible to adjust the width of the partial leaf opening as a percentage of the total gate travel. Adjustable from 0 to 99% in 1% steps. 00 = no partial opening 01 = minimum partial opening 99 = maximum partial opening	50
t	TIME-OUT It is advisable to set a value higher than the time taken by the gate to open or close fully. Adjustable from 0 to 59 sec. in 1 second steps. Subsequently, display changes to minutes and tens of seconds (separated by a point) and time is adjusted in 10-second steps, up to the maximum value of 9.5 minutes. E.g.: if the display shows 2.5, pause time is 2 min. and 50 secs.  When using a system with MASTER/SLAVE configuration you must set a WORK TIME on the MASTER unit that takes into account the movement time of both leaves.	2.0
01	OUT 1: Allows output OUT (open collector N.O.) to be activated in one of the following functions: 00 = Always enabled (supplies 24V voltage= with a max absorption of 100 mA) 01 = FAIL-SAFE (monitors the correct operation of the connected traditional photocells) 02 = WARNING LIGHT (off when closed, on during opening and open/pause, flashing during closing) 03 = COURTESY LIGHT (see next function) 04 = ALARM, BATTERY operation 05 = gate OPEN or PAUSED 06 = gate CLOSED 07 = gate in MOTION 08 = gate OPENING 09 = gate CLOSING 10 = ACTIVE safety 11 = timed output that can be activated by second radio channel (see next function) 12 = output that can be activated by second radio channel (step function)	00
t1	TIMING OF OUT 1 (only if option 03 or 11 is selected at the previous step): Can be used to adjust timing of output OUT if a timed function was selected (e.g. 03 or 11) from 1 to 99 minutes in 1 minute steps.	02
0b	OPEN B / CLOSE / EDGE SAFETY DEVICE: It is possible to select the use of OPEN B input as partial opening, CLOSE command or EDGE SAFETY DEVICE. 00 = OPEN B 01 = CLOSE 02 = SAFETY EDGE SAFETY (N.C. contact)  If you select a function logic that involves the use of the CLOSE command (logic b, bC, C) this function will be preset to 01 and it will not be possible to change it.	00
SP	STOP / EDGE SAFETY DEVICE It is possible to select the use of STOP input as STOP or EDGE SAFETY DEVICE. 00 = STOP 01 = SAFETY EDGE SAFETY (N.C. contact)	00
P	PARTIAL REVERSE: It is possible to set the reverse type (complete or partial) when an obstacle is encountered or when a safety edge is triggered. y = Partial reverse activation. When an obstacle is encountered or when a safety edge is triggered the leaf reverses movement for approximately 2" and will then stop no = Partial reverse deactivation. When an obstacle is encountered or when a leaf safety edge is triggered it completely reverses movement and will place itself in open or closed position	no
Lc	MOTOR LOCK: It is possible to select the use of the motor lock during battery operation: y = the motor lock continues to operate regularly even during battery operation no = when the system switches to battery operation, the motor lock remains open.	y

Display	Function	Default														
AS	<p>SERVICE REQUEST - CYCLE COUNTER (combined with the two successive functions):</p> <p>y = when the set number of cycles is reached with successive functions nc and nd, the system carries out an 8 sec. preflashing sequence (in addition to the sequence already set using the PF function) before each movement.</p> <p>no = successive functions nc and nd indicate how many cycles the system has performed up to the maximum possible display of 99.990.</p> <p> If the number of cycles is higher than 99.990, the two successive functions nc and nd will show 99 and 99 respectively.</p> <p>This function may be useful for setting programmed maintenance operations or for checking work cycles performed.</p>	no														
nc	<p>CYCLE PROGRAMMING (THOUSANDS):</p> <p>If AS = y the display indicates the number of thousands of cycles after which service is required (may be set from 0 to 99).</p> <p>If AS = no the display indicates the number of thousands of cycles performed. The value displayed is updated with the sequence of cycles, interacting with the value of nd.</p> <p> If AS = no press keys + and - for 5 sec. to zero the cycle counter.</p>	00														
nd	<p>CYCLE PROGRAMMING (TENS):</p> <p>If AS = y the display indicates the number of tens of cycles after which service is required (may be set from 0 to 99).</p> <p>If AS = no the display indicates the number of tens of cycles performed. The value displayed is updated with the sequence of cycles, interacting with the value of nc.</p> <p> Example: if the system has performed 11.218, it will display nc = 11 and nd = 21</p>	00														
St	<p>STATUS OF AUTOMATED SYSTEM:</p> <p>Exit from programming, data storage, and return to gate status display.</p> <table border="0"> <tr> <td>00 = CLOSED</td> <td>07 = FAIL SAFE in progress</td> </tr> <tr> <td>01 = OPEN</td> <td>08 = BUS-2EASY device check in progress</td> </tr> <tr> <td>02 = Stop then "OPEN"</td> <td>09 = Preflashing then "OPEN"</td> </tr> <tr> <td>03 = Stop then "CLOSE"</td> <td>10 = Preflashing then "CLOSE"</td> </tr> <tr> <td>04 = In "PAUSE"</td> <td>11 = OPEN in Partial Opening</td> </tr> <tr> <td>05 = During opening stage</td> <td>12 = in PAUSE Partial Opening</td> </tr> <tr> <td>06 = During closing stage</td> <td></td> </tr> </table>	00 = CLOSED	07 = FAIL SAFE in progress	01 = OPEN	08 = BUS-2EASY device check in progress	02 = Stop then "OPEN"	09 = Preflashing then "OPEN"	03 = Stop then "CLOSE"	10 = Preflashing then "CLOSE"	04 = In "PAUSE"	11 = OPEN in Partial Opening	05 = During opening stage	12 = in PAUSE Partial Opening	06 = During closing stage		
00 = CLOSED	07 = FAIL SAFE in progress															
01 = OPEN	08 = BUS-2EASY device check in progress															
02 = Stop then "OPEN"	09 = Preflashing then "OPEN"															
03 = Stop then "CLOSE"	10 = Preflashing then "CLOSE"															
04 = In "PAUSE"	11 = OPEN in Partial Opening															
05 = During opening stage	12 = in PAUSE Partial Opening															
06 = During closing stage																

6 STORING RADIO CODE

The control board is equipped with an integrated dual channel decoding system (DS, SLH, LC/RC) known as OMNIDEC. This system can use an additional receiving module (Fig. 15 ref. ①) and radiocontrols of the same frequency to store both total opening (OPEN A) and partial opening (OPEN B) of the automated system.

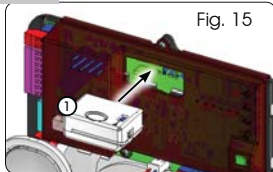

The 3 types of radio coding (DS, SLH, LC/RC) can co-exist at the same time on the two channels. It is possible to enter up to 256 radio codes subdivided between OPEN A and OPEN B.

To use the different coding systems on the same channel, finish the learning process for each system and then repeat the procedure for another.

Do not connect any radio devices on SLAVE-configured equipment

6.1 STORING DS RADIOCONTROLS

It is possible to store a maximum of 256 codes divided between OPEN A and OPEN B/CLOSE.

- On the DS radiocontrol, select the required ON - OFF combination of the 12 dip-switches.
- Press and hold down push-button + (SW3) or - (SW2) and then press the SETUP push-button (SW4), to store total opening (OPEN A) or partial opening (OPEN B/CLOSE) respectively. The corresponding LED will begin to flash slowly for 5 secs.
- Release both push-buttons.
- Within this 5 second period, press the required push-button on the radiocontrol.
- The corresponding LED will come on with a fixed light for 1 second and then go off to indicate the setting has been stored.
- To add other codes other than the one you have recently stored, repeat the procedure from point 1.

- To use radiocontrols with the same code, copy the ON - OFF combination to the other radiocontrols without the need to change anything on the control board.

6.2 STORING SLH RADIOCONTROLS

 **It is possible to store a maximum of 256 codes divided between OPEN A and OPEN B/CLOSE.**

- On the SLH radiocontrol, press and hold down P1 and P2 simultaneously.
- The radiocontrol LED will begin to flash.
- Release both push-buttons.
- Press and hold down push-button + (SW3) or – (SW2) and then press the SETUP push-button (SW4), to store total opening (OPEN A) or partial opening (OPEN B/CLOSE) respectively. The corresponding LED will begin to flash slowly for 5 secs.
- Release both push-buttons.
- Within this 5 sec. period while the radiocontrol LED is still flashing, press and hold down the required push-button on the radiocontrol (the radiocontrol LED will come on with a fixed light).
- The corresponding LED will come on with a fixed light for 2 seconds and then go off to indicate the setting has been stored.
- Release the radiocontrol push-button.
- Press the stored radiocontrol push-button twice in quick succession.

 **The automated system will carry out an opening control. Ensure the automated device is free of any obstacle by people or things.**

To enable other radiocontrols with the same system code, transfer the system code of the stored radiocontrol push-button to the corresponding push-button of the radiocontrols to be added, following the procedure below:

- On the stored radiocontrol, press and hold down P1 and P2 simultaneously.
- The radiocontrol LED will begin to flash.
- Release both push-buttons.
- Press the stored push-button and hold down (the radiocontrol LED will come on with a fixed light).
- Bring the radiocontrols closer to one another, press and hold down the corresponding push-button of the radiocontrol to be added, releasing only once the LED on the radiocontrol has issued a double flash to indicate that it has been stored.
- Press the stored radiocontrol push-button twice in quick succession.

 **The automated system will carry out an opening control. Ensure the automated device is free of any obstacle by people or things.**

6.3 STORING LC/RC RADIOCONTROLS

 **It is possible to store a maximum of 256 codes divided between OPEN A and OPEN B/CLOSE.**

 **Use the LC/RC remote controls only with a 433 MHz receiving module.**

- Press and hold down push-button + (SW3) or – (SW2) and then press the SETUP push-button (SW4), to store total opening (OPEN A) or partial opening (OPEN B/CLOSE) respectively. The corresponding LED will begin to flash slowly for 5 secs.
- Release the push-button.
- Within this 5 second period, press the required push-button on the LC/RC remote control.
- The LED will come on with a fixed light for 1 second, indicating that the unit has been stored, and then resume flashing for an additional 5 seconds during which time another radiocontrol may be stored.
- Once the 5 seconds are up, the LED will go off to indicate that the procedure is complete.

6.3.1 STORING LC/RC RADIOCONTROLS REMOTELY

With LC/RC radiocontrols, other radiocontrols may be stored in remote mode, i.e. without operating directly on the board, using a previously stored radiocontrol.

- Obtain a radiocontrol already stored on one of its 2 channels (OPEN A or OPEN B/CLOSE).
- Press and hold down push-buttons P1 and P2 simultaneously until both LEDs flash slowly for 5 secs.
- Within 5 seconds, push the previously stored radiocontrol push-button to activate the learning stage on the selected channel.
- The LED on the board corresponding to the channel being stored flashes for 5 seconds, within which time the code of another radiocontrol must be sent.
- The LED will come on with a fixed light for 1 second, indicating that the unit has been stored, and then resume flashing for an additional 5 seconds during which time other radiocontrols may be stored and then it will go off.

6.4 RADIOCONTROLS DELETION PROCEDURE

To delete **ALL** the codes of the radiocontrols entered, simply press down together the two push-buttons + (SW3) and – (SW2), then press the SETUP push-button (SW4) for 1 second, and hold the first two push-buttons pressed for 10 secs.

- The 2 LEDs RADIO1 and RADIO2 will flash quickly for 10 secs.
- The 2 LEDs will come on with a fixed light for 2 seconds and then go off (deletion carried out).
- Release both push-buttons.

 **This operation is NOT reversible. All the codes of the radiocontrols stored as OPEN A and as OPEN B/CLOSE will be deleted.**

7 OPERATIONAL START-UP

7.1 CHECKING THE LEDs

After making all the connections and powering the board, check the status of the LEDs against the status of the inputs in the following table (in Fig. 16, the condition where the automated system is closed in stand-by). These LEDs indicate the status of the board inputs and are of considerable importance to automated system movement:

Note that:  **LED ON** = contact closed  **LED OFF** = contact open

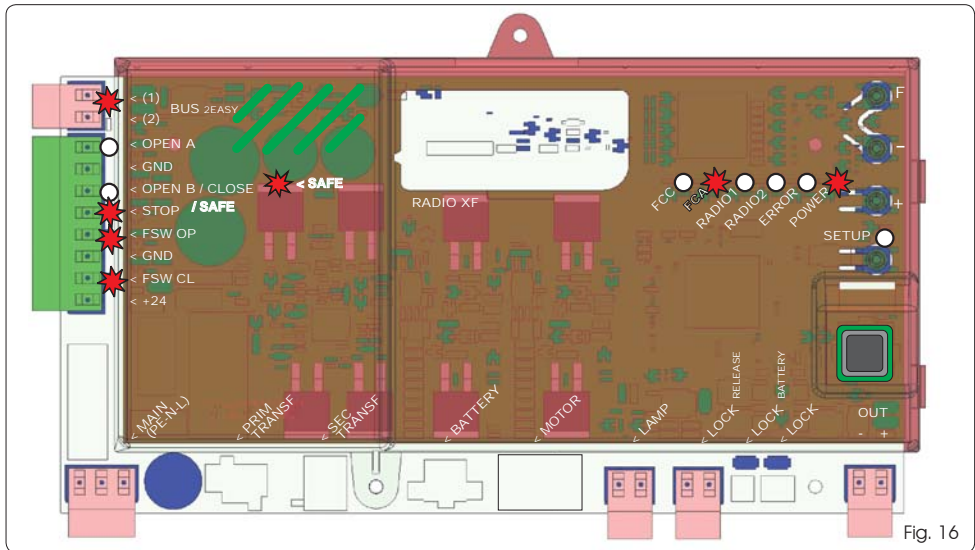







Fig. 16

Leds FCA and FCC represent the N.C. contacts of the limit switch built into the board that open when engaged and turn off the associated LED:

Automated system CLOSED	FCA 
	FCC  FCC engaged
Automated system OPEN	FCA 
	FCC 

Tab. 3 - Description of POWER LED

Fixed ON	Mains-powered
Flashing	Battery-powered
Off	Board off

 **The STOP (SAFE), FSW CL, FSW OP, OPEN B inputs configured as SAFE are safety inputs with N.C. (Normally Closed) contact and therefore the corresponding LEDs must be ON when the automated system is at rest, and off when the connected device is used.**

 **The OPEN A, OPEN B/CLOSE inputs are inputs with N.O. (Normally Open) contact and therefore the corresponding LEDs must be OFF when the automated system is at rest, and on when the connected device is used.**

 **When using equipment programmed as SLAVE the LEDs corresponding to terminal board J13 must be off.**

 **ERROR LED flashing indicates alarm in progress (situation does not impair gate operation)**

 **ERROR LED on with a fixed light indicates an error in progress (situation that locks operation until the cause of the error has been removed)**

7.2 BATTERY OPERATION

 **ATTENTION**

To optimise energy consumption and protect the charge, during battery operation, when the automated system is stopped and the system is on stand-by, the LCD1 display, the BUS 2easy LED and the FCC and FCA LED will be off while the POWER LED flashes.

In this phase it is in any case possible to view the state of the automated system. To do this it is sufficient to briefly press "+" on the board. Following brief pressure, the LCD1 display shows the state of the automated system for approximately 2 seconds to then go off again. Instead, during normal operation all the diagnostic LEDs and the display state signals become consistent with the state of the automated system (see Fig. 16).

7.3 POSITIONING LIMIT SWITCHES



To ensure correct positioning of the limit switch magnets, the control unit must be installed and correctly connected with all control and safety accessories.

The operator is equipped with a magnetic limit switch sensor built directly into the electronic control board. The gate is stopped, during opening or closing, when the polarised magnet secured to the upper part of the rack activates the sensor.

1. Check that the operator is set for manual operating mode as described in the instructions for the operator.
2. Move the gate to **opening** position manually, leaving 40 mm from the limit switch mechanical stop (see Fig. 17).
3. Slide the magnet with the **CIRCLE** on the rack in the direction of the motor. As soon as the LED for the FCA limit switch on the board goes off, secure with the appropriate screws.
4. Move the gate to **closing** position manually, leaving 40 mm from the limit switch mechanical stop.
5. Slide the magnet with the **SQUARE** on the rack in the direction of the motor. As soon as the LED for the FCC limit switch on the board goes off, secure with the appropriate screws.
6. Check that the relevant limit switch LED goes off correctly at the end of the opening and closing movement and make the necessary changes to the position of the limit switch magnet position if necessary.

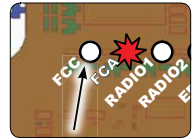
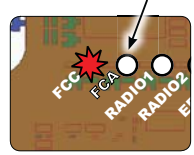

To avoid damage to the operator and/or interruptions in the operation of the automated system, approximately 40 mm must be left from the mechanical limit switch stops.



For correct operation of the operator, the magnet with the **CIRCLE** must be used as an **OPENING** limit switch and the magnet with the **SQUARE** must be used as a **CLOSING** limit switch.

(SEE FIG. 17)

When using a system with **MASTER/SLAVE** configuration, the limit switch magnets must be installed as shown in Fig. 18.

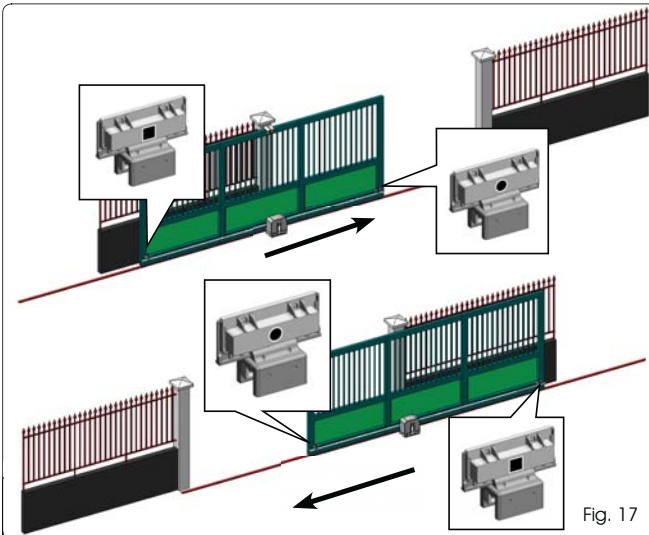

Fig. 17

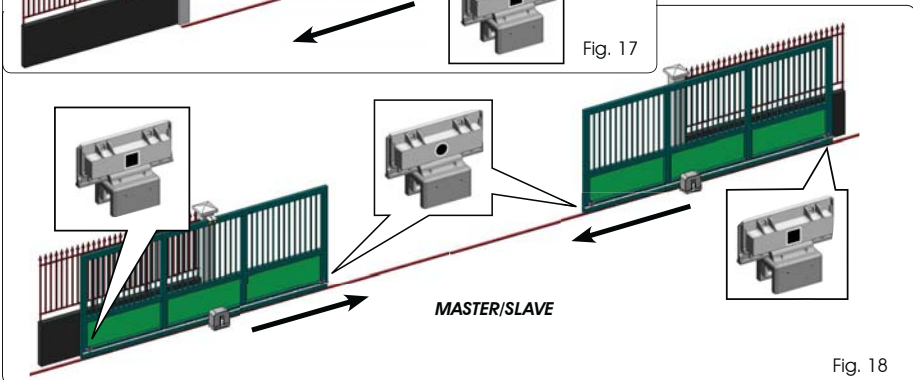





Fig. 18

7.4 MASTER / SLAVE CONFIGURATIONS

Should you need to build a system with opposing leaves that must be activated simultaneously for opening and closing the gate, you must connect and configure two E721 devices in Master/Slave mode. The MASTER equipment (parameter **Ct** of the first programming level configured as **FR**) must have all the necessary connections for correct operation of the system (photocells, safety switches, radio, opening pulses, flashing light) while the SLAVE equipment (parameter **Ct** of the first programming level configured as **SL**), must not be wired with terminal board J13, as all the inputs present are completely ignored. The two devices will communicate with each other through BUS-2EASY using two-pole **POLARISED** wiring on the J12 terminal board. The MASTER device will completely control the SLAVE device through BUS-2EASY and will manage all the movements and time of both leaves.

-  **Avoid any type of connection and wiring to terminal board J13 of the SLAVE unit.**
-  **The BUS connection between the two boards must be POLARISED following the sequence of the poles of the J12 terminal board (POLE (1) - POLE (2)) - (see Fig. 19).**
-  **When a unit is configured as a SLAVE, this will force the values of some programming parameters no longer displayed in the menu (**L0-PA-Pb-Ph-Op**). By placing the board in MASTER mode again, the previously forced values are stored in the program.**

7.4.1 MASTER / SLAVE WIRING

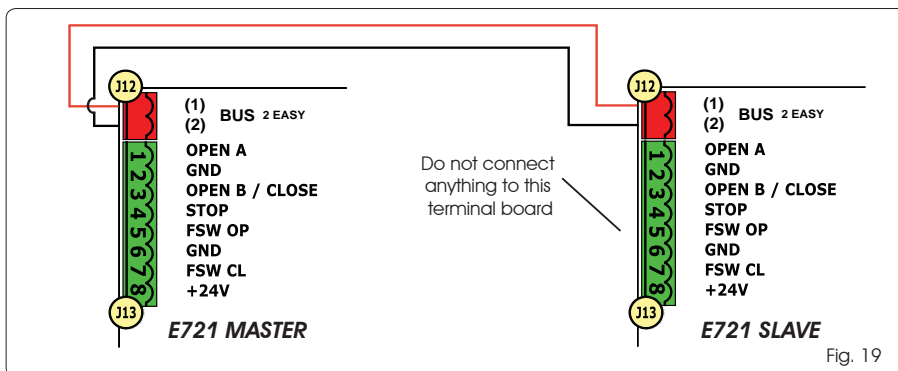

7.4.2 MASTER/SLAVE SETUP PROCEDURE

-  **The SETUP request signalled by the flashing **50** on the display can occur both on the MASTER unit and on the SLAVE unit. In the latter case, the MASTER unit will display an error **91**. In any case, the SETUP procedure can only be started from the MASTER unit.**

To SETUP a MASTER/SLAVE system, follow the steps below:

1. Release both leaves, place them in the middle of travel and lock again (see procedure no.1 Par. 7.5 SETUP)
2. Keep pressed the SETUP button on the MASTER board until the MASTER gate begins to move.
3. At this point the MASTER gate will perform a complete SETUP procedure (see Par. 7.5 SETUP)
4. Once you have correctly completed the SETUP of the MASTER board, the complete SETUP procedure of the SLAVE board begins (see Par. 7.5 SETUP).
5. Once this procedure has also been completed the MASTER checks the position of the SLAVE leaf and places it in the same position (open or closed) as the MASTER leaf.
6. Procedure completed.

-  **In case of error or non-completion of the above-mentioned SETUP procedure, you must repeat it completely starting from point no.1.**

7.4 SETUP

 When the board is powered when no SETUP has ever been carried out, or if the board requires it, the code **50** will flash on the display together with the SETUP LED to indicate that SETUP must be carried out.

 To ensure the effective outcome of the SETUP procedure, carefully check the correct polarity of the magnetic limit switches as described in the previous paragraph.

Proceed as follows to carry out the SETUP:

1. Place the gate at half its travel (very important for a successful SETUP) and check that both the FCA and FCC LEDs are on. Otherwise, the board will signal error 12 (see tab. 5)
2. Press and hold the SETUP (SW4) push-button until the gate begins to move slowly and stops when it reaches the limit switch. If the limit switch reached is the closing switch (with the **SQUARE**) the device stores that point as the **closing** stop, conversely if the limit switch is the opening switch (with the **CIRCLE**) the device stores that point as the **opening** stop. During that stage, **51** flashes on the display
3. The gate automatically begins to move slowly in the opposite direction and then stops when it reaches the limit switch. If the limit switch reached is the opening switch (with the **SQUARE**) the device stores that point as the **opening** stop, conversely if the limit switch is the closing switch (with the **SQUARE**) the device stores that point as the **closing** stop. During that stage, **53** flashes on the display
4. According to the final limit switch reached, the device takes up a status of closed (**00**) or open (**01**). In the second case, issue an OPEN pulse to close the gate.

8 TESTING THE AUTOMATED SYSTEM

After installation and programming, check the system is operating correctly. Above all, check that the safety devices operate correctly and ensure that the current safety regulations are met.

 Remember that the second programming level features the encoder configuration parameter (parameter EC). This "virtual" encoder located on the board acts as an anti-crushing device. During the open/closing phase, should the gate collide with an obstacle, the "virtual" encoder will cause the motion to reverse. At the next motion in the same direction, an obstacle in the same position will cause the motor to stop. It is essential to correctly configure this parameter to adjust the correct sensitivity of the "virtual" encoder with respect to obstacles during motion.

9 ALARM AND ERROR SIGNALS

If **alarms** occur (conditions that do not impair the operation of the gate) or **errors** (conditions that lock the gate operation) the display shows a number relating to the current condition.

 The ALARM or ERROR signals disappear at the next cycle only if the triggering cause is removed.

9.1 ALARMS

 When an ALARM occurs, the ERROR LED begins to flash and a number relating to the current fault appears on the display when the + and - keys are pressed.

Tab. 4 indicates all the alarms that may be shown on the display.

Tab. 4 - Alarms

22	Limited MOTOR current
24	LAMP output short-circuited
27	Obstacle detection (visible for 10 secs)
30	XF radio code memory-module full (visible for 10 secs)
40	Service request
46	Forced default programming reset

9.2 ERRORS

 When an ERROR occurs, LED DL20 comes on with a fixed light and a number relating to the current fault appears on the display when the + and - keys are pressed.

Tab. 5 indicates all the errors that may be shown on the display.

Tab. 5 - Errors

01	Board faulty
03	Motor faulty
06	Motor lock locked closed (check the motor lock and replace if necessary)
07	Gate too heavy or too much friction (try to increase motor power)
08	BUS-2EASY device error (e.g. same address on two photocell pairs; check address)
10	Both limit switches with the same polarity
12	Limit switch engaged at the beginning of SETUP
15	Time-out finished
90	No communication with the SLAVE unit - SLAVE unit missing
91	Error on the SLAVE unit
92	Error on the SLAVE unit

 Errors **90**, **91** and **92** are displayed only on E721 configured as MASTER and in particular **91** and **92** indicate errors present on the SLAVE unit. Should such errors be displayed, we recommend you check on the SLAVE unit the type of error shown on the display to solve it and restore correct operation of the system.

10 FUNCTION LOGICS

 **In brackets, the effects on the other inputs when the pulse is active.**

 **If enabled during leaf motion, the SAFE command will immediately and completely reverse it; when the automated system is stopped, if kept enabled it will prevent its movement.**

 **The CLOSE command can be enabled on the OPEN B input from programming level 2.**

LOGIC "E"				PULSES			
STATUS OF AUTOMATED SYSTEM	OPEN A	OPEN B	CLOSE	STOP	FSW OP	FSW CL	FSW CL/OP
CLOSED	opens the gate	opens the gate partially	no effect	no effect (OPEN inhibited)	no effect (OPEN inhibited)	no effect	no effect (OPEN inhibited)
DURING OPENING	locks operation (1)	locks operation	recloses the gate	locks operation	see 2nd level prog.	no effect	locks and opens on disengagement (OPEN locks - stores CLOSE)
OPEN	recloses the gate (1)	recloses the gate	recloses the gate	no effect (OPEN/CLOSE inhibited)	no effect	no effect (CLOSE inhibited)	no effect (OPEN/CLOSE inhibited)
DURING CLOSING	reopens the gate	reopens the gate	no effect	locks operation	no effect	reverses to opening (see 2nd level prog.)	locks and opens on disengagement (OPEN locks - stores CLOSE)
LOCKED	closes the gate	closes the gate	closes the gate	no effect (OPEN/CLOSE inhibited)	no effect (OPEN inhibited)	no effect (CLOSE inhibited)	no effect (OPEN locks - stores CLOSE)

LOGIC "EP"				PULSES			
STATUS OF AUTOMATED SYSTEM	OPEN A	OPEN B	CLOSE	STOP	FSW OP	FSW CL	FSW CL/OP
CLOSED	opens the gate	opens the gate partially	no effect	no effect (OPEN inhibited)	no effect (OPEN inhibited)	no effect	no effect (OPEN inhibited)
DURING OPENING	locks operation (1)	locks operation	recloses the gate	locks operation	see 2nd level prog.	no effect	locks and opens on disengagement (OPEN locks - stores CLOSE)
OPEN	recloses the gate (1)	recloses the gate	recloses the gate	no effect (OPEN/CLOSE inhibited)	no effect	no effect (CLOSE inhibited)	no effect (OPEN/CLOSE inhibited)
DURING CLOSING	locks operation	locks operation	no effect	locks operation	no effect	reverses to opening (see 2nd level prog.)	locks and opens on disengagement (OPEN locks - stores CLOSE)
LOCKED	resumes motion in reverse direction. After STOP, always closes	resumes motion in reverse direction. After STOP, always closes	closes the gate	no effect (OPEN/CLOSE inhibited)	no effect (OPEN inhibited)	no effect (CLOSE inhibited)	no effect (OPEN locks - stores CLOSE)

LOGIC "A"				PULSES			
STATUS OF AUTOMATED SYSTEM	OPEN A	OPEN B	CLOSE	STOP	FSW OP	FSW CL	FSW CL/OP
CLOSED	opens and recloses after the pause time	opens the gate partially and closes it after pause time B	no effect	no effect (OPEN inhibited)	no effect (OPEN inhibited)	no effect	no effect (OPEN inhibited)
DURING OPENING	no effect (1)	no effect	recloses the gate	locks operation	see 2nd level prog.	no effect	locks and opens on disengagement (stores CLOSE)
OPEN IN PAUSE	reloads pause time (1)	reloads pause time B	recloses the gate	locks operation	no effect	reloads pause time (CLOSE inhibited)	reloads pause time (CLOSE inhibited)
DURING CLOSING	reopens the gate	reopens the gate	no effect	locks operation	no effect	reverses to opening (see 2nd level prog.)	locks and opens on disengagement (stores CLOSE)
LOCKED	closes the gate	closes the gate	closes the gate	no effect (OPEN/CLOSE inhibited)	no effect (OPEN inhibited)	no effect (CLOSE inhibited)	no effect (OPEN/CLOSE inhibited)

LOGIC "AI"				PULSES			
STATUS OF AUTOMATED SYSTEM	OPEN A	OPEN B	CLOSE	STOP	FSW OP	FSW CL	FSW CL/OP
CLOSED	opens and recloses after the pause time	opens the gate partially and closes it after pause time B	no effect	no effect (OPEN inhibited)	no effect (OPEN inhibited)	no effect	no effect (OPEN inhibited)
DURING OPENING	no effect (1)	no effect	recloses the gate	locks operation	see 2nd level prog.	continues to open and recloses immediately	locks and opens on disengagement (stores CLOSE)
OPEN IN PAUSE	reloads pause time (1)	reloads pause time B	recloses the gate	locks operation	no effect	locks and immediately closes on disengagement	reloads pause time (CLOSE inhibited)
DURING CLOSING	reopens the gate	reopens the gate	no effect	locks operation	no effect	reverses to opening (see 2nd level prog.)	locks and opens on disengagement (stores CLOSE)
LOCKED	closes the gate	closes the gate	closes the gate	no effect (OPEN/CLOSE inhibited)	no effect (OPEN inhibited)	no effect (CLOSE inhibited)	no effect (OPEN/CLOSE inhibited)

(1) During the partial opening cycle, an OPEN A pulse causes total opening

LOGIC 'AP'		PULSES					
STATUS OF AUTOMATED SYSTEM	OPEN A	OPEN B	CLOSE	STOP	FSW OP	FSW CL	FSW CL/OP
CLOSED	opens and recloses after the pause time	opens the gate partially and closes it after pause time B	no effect	no effect (OPEN inhibited)	no effect (OPEN inhibited)	no effect	no effect (OPEN inhibited)
DURING OPENING	locks operation (1)	locks operation	recloses the gate	locks operation	see 2nd level prog.	no effect	locks and opens on disengagement (OPEN locks - stores CLOSE)
OPEN IN PAUSE	locks operation (1)	locks operation	recloses the gate	locks operation	no effect	reloads pause time (CLOSE inhibited)	reloads pause time (CLOSE inhibited)
DURING CLOSING	reopens the gate	reopens the gate	no effect	locks operation	no effect	reverses to opening (see 2nd level prog.)	locks and opens on disengagement (OPEN locks - stores CLOSE)
LOCKED	closes the gate	closes the gate	closes the gate	no effect (OPEN/CLOSE inhibited)	no effect (OPEN inhibited)	no effect (CLOSE inhibited)	no effect (OPEN/CLOSE inhibited)

LOGIC 'AI' (2)		PULSES					
STATUS OF AUTOMATED SYSTEM	OPEN A	OPEN B	CLOSE	STOP	FSW OP	FSW CL	FSW CL/OP
CLOSED	opens and recloses after the pause time	opens the gate partially and closes it after pause time B	no effect	no effect (OPEN inhibited)	no effect (OPEN inhibited)	no effect	no effect (OPEN inhibited)
DURING OPENING	no effect (1)	no effect	recloses the gate	locks operation	reverses to closing (1)	no effect	locks and opens on disengagement (stores CLOSE)
OPEN IN PAUSE	reloads pause time (1)	reloads pause time	recloses the gate	locks operation	no effect	reloads pause time (CLOSE inhibited)	reloads pause time (CLOSE inhibited)
DURING CLOSING	reopens the gate	reopens the gate	no effect	locks operation	no effect	reverses to opening (see 2nd level prog.)	locks and opens on disengagement (stores CLOSE)
LOCKED	closes the gate	closes the gate	closes the gate	no effect (OPEN/CLOSE inhibited)	no effect (OPEN inhibited)	no effect (CLOSE inhibited)	no effect (OPEN/CLOSE inhibited)

LOGIC 'S'		PULSES					
STATUS OF AUTOMATED SYSTEM	OPEN A	OPEN B	CLOSE	STOP	FSW OP	FSW CL	FSW CL/OP
CLOSED	opens and recloses after the pause time	opens the gate partially and closes it after pause time B	no effect	no effect (OPEN inhibited)	no effect (OPEN inhibited)	no effect	no effect (OPEN inhibited)
DURING OPENING	reverses to closing (1)	reverses to closing (1)	recloses the gate	locks operation	see 2nd level prog.	continues to open and recloses immediately	locks and opens on disengagement (stores CLOSE)
OPEN IN PAUSE	recloses the gate (1)	recloses the gate	recloses the gate	locks operation	no effect	locks and immediately closes on disengagement	locks and closes on disengagement
DURING CLOSING	reopens the gate	reopens the gate	no effect	locks operation	no effect	reverses to opening (see 2nd level programming) and closes immediately at the end	locks and on disengagement opens and at the end immediately closes
LOCKED	closes the gate	closes the gate	closes the gate	no effect (OPEN/CLOSE inhibited)	no effect (OPEN inhibited)	no effect (CLOSE inhibited)	no effect (OPEN/CLOSE inhibited)

LOGIC 'SP'		PULSES					
STATUS OF AUTOMATED SYSTEM	OPEN A	OPEN B	CLOSE	STOP	FSW OP	FSW CL	FSW CL/OP
CLOSED	opens and recloses after the pause time	opens the gate partially and closes it after pause time B	no effect	no effect (OPEN inhibited)	no effect (OPEN inhibited)	no effect	no effect (OPEN inhibited)
DURING OPENING	locks operation (1)	locks operation	recloses the gate	locks operation	see 2nd level prog.	continues to open and recloses immediately	locks and on disengagement opens and at the end immediately closes (OPEN locks - stores CLOSE)
OPEN IN PAUSE	recloses the gate (1)	recloses the gate	recloses the gate	locks operation	no effect	locks and immediately closes on disengagement	locks and immediately closes on disengagement
DURING CLOSING	locks operation	locks operation	no effect	locks operation	no effect	reverses to opening (see 2nd level prog.)	locks and opens on disengagement (stores CLOSE)
LOCKED	resumes motion in reverse direction. After STOP, always closes	resumes motion in reverse direction. After STOP, always closes	recloses the gate	no effect (OPEN/CLOSE inhibited)	no effect (OPEN inhibited)	no effect (CLOSE inhibited)	no effect (OPEN/CLOSE inhibited)

(1) During the partial opening cycle, an OPEN A pulse causes total opening

LOGIC 'SA'		PULSES					
STATUS OF AUTOMATED SYSTEM	OPEN A	OPEN B	CLOSE	STOP	FSW OP	FSW CL	FSW CL/OP
CLOSED	opens and recloses after the pause time	Opens the gate partially and closes it after pause time B	no effect	no effect (OPEN inhibited)	no effect (OPEN inhibited)	no effect	no effect (OPEN inhibited)
DURING OPENING	no effect (1)	no effect	recloses the gate	locks operation	see 2nd level prog.	no effect	locks and opens on disengagement (stores CLOSE)
OPEN IN PAUSE	recloses the gate (1)	recloses the gate	recloses the gate	locks operation	no effect	reloads pause time (CLOSE inhibited)	reloads pause time (CLOSE inhibited)
DURING CLOSING	reopens the gate	reopens the gate	no effect	locks operation	no effect	reverses to opening (see 2nd level prog.)	locks and opens on disengagement (stores CLOSE)
LOCKED	closes the gate	closes the gate	closes the gate	no effect (OPEN/CLOSE inhibited)	no effect (OPEN inhibited)	no effect (CLOSE inhibited)	no effect (OPEN/CLOSE inhibited)

LOGIC 'B'		PULSES					
STATUS OF AUTOMATED SYSTEM	OPEN A	/	CLOSE	STOP	FSW OP	FSW CL	FSW CL/OP
CLOSED	opens the gate	/	no effect	no effect (OPEN inhibited)	no effect (OPEN inhibited)	no effect	no effect (OPEN inhibited)
DURING OPENING	no effect	/	closes the gate	locks operation	see 2nd level prog.	no effect	locks and opens on disengagement (stores OPEN/CLOSE)
OPEN	no effect	/	closes the gate	no effect (OPEN/CLOSE inhibited)	no effect	no effect (CLOSE inhibited)	no effect (OPEN/CLOSE inhibited)
DURING CLOSING	opens the gate	/	no effect	locks operation	no effect	reverses to opening (see 2nd level prog.)	locks and opens on disengagement (stores OPEN/CLOSE)
LOCKED	opens the gate	/	closes the gate	no effect (OPEN/CLOSE inhibited)	no effect (OPEN inhibited)	no effect (CLOSE inhibited)	no effect (OPEN/CLOSE inhibited)

LOGIC bC		PULSES DURING OPENING/COMMANDS MAINTAINED DURING CLOSING			PULSES		
STATUS OF AUTOMATED SYSTEM	OPEN A	/	CLOSE	STOP	FSW OP	FSW CL	FSW CL/OP
CLOSED	opens the gate	/	no effect	no effect (OPEN inhibited)	no effect (OPEN inhibited)	no effect	no effect (OPEN inhibited)
DURING OPENING	no effect	/	closes the gate	locks operation	see 2nd level prog.	no effect	locks and opens on disengagement (stores OPEN/CLOSE)
OPEN	no effect	/	closes the gate	no effect (OPEN/CLOSE inhibited)	no effect	no effect (CLOSE inhibited)	no effect (OPEN/CLOSE inhibited)
DURING CLOSING	opens the gate	/	no effect	locks operation	no effect	reverses to opening (see 2nd level prog.)	locks and opens on disengagement (stores OPEN/CLOSE)
LOCKED	opens the gate	/	closes the gate	no effect (OPEN/CLOSE inhibited)	no effect (OPEN inhibited)	no effect (CLOSE inhibited)	no effect (OPEN/CLOSE inhibited)

LOGIC 'C'		COMMANDS MAINTAINED		PULSES			
STATUS OF AUTOMATED SYSTEM	OPEN A	/	CLOSE	STOP	FSW OP	FSW CL	FSW CL/OP
CLOSED	opens the gate	/	no effect	no effect (OPEN inhibited)	no effect (OPEN inhibited)	no effect	no effect (OPEN inhibited)
DURING OPENING	no effect	/	closes the gate	locks operation	see 2nd level prog.	no effect	locks and on disengagement 2nd level prog.
OPEN	no effect	/	closes the gate	no effect (OPEN/CLOSE inhibited)	no effect	no effect (CLOSE inhibited)	no effect (OPEN/CLOSE inhibited)
DURING CLOSING	opens the gate	/	no effect	locks operation	no effect	locks operation	locks operation
LOCKED	opens the gate	/	closes the gate	no effect (OPEN/CLOSE inhibited)	no effect (OPEN inhibited)	no effect (CLOSE inhibited)	no effect (OPEN/CLOSE inhibited)

(1) During the partial opening cycle, an OPEN A pulse causes total opening
 (2) When turned on, the board checks the inputs and if an OPEN A or B command is active, it opens the leaf or gate. Otherwise it closes it.

Le descrizioni e le illustrazioni del presente manuale non sono impegnative. La FAAC si riserva il diritto, lasciando inalterate le caratteristiche essenziali dell'apparecchiatura, di apportare in qualunque momento e senza impegnarsi ad aggiornare la presente pubblicazione, le modifiche che essa ritiene convenienti per miglioramenti tecnici o per qualsiasi altra esigenza di carattere costruttivo o commerciale.

The descriptions and illustrations contained in the present manual are not binding. FAAC reserves the right, whilst leaving the main features of the equipments unaltered, to undertake any modifications it holds necessary for either technical or commercial reasons, at any time and without revising the present publication.

Les descriptions et les illustrations du présent manuel sont fournies à titre indicatif. FAAC se réserve le droit d'apporter à tout moment les modifications qu'elle jugera utiles sur ce produit tout en conservant les caractéristiques essentielles, sans devoir pour autant mettre à jour cette publication.

Die Beschreibungen und Abbildungen in vorliegendem Handbuch sind unverbindlich. FAAC behält sich das Recht vor, ohne die wesentlichen Eigenschaften dieses Gerätes zu verändern und ohne Verbindlichkeiten in Bezug auf die Neufassung der vorliegenden Anleitungen, technisch bzw. konstruktiv/kommerziell bedingte Verbesserungen vorzunehmen.

Las descripciones y las ilustraciones de este manual no comportan compromiso alguno. FAAC se reserva el derecho, dejando inmutadas las características esenciales de los aparatos, de aportar, en cualquier momento y sin comprometerse a poner al día la presente publicación, todas las modificaciones que considere oportunas para el perfeccionamiento técnico o para cualquier otro tipo de exigencia de carácter constructivo o comercial.

De beschrijvingen in deze handleiding zijn niet bindend. FAAC behoudt zich het recht voor op elk willekeurig moment de veranderingen aan te brengen die het bedrijf nuttig acht met het oog op technische verbeteringen of alle mogelijke andere productie- of commerciële eisen, waarbij de fundamentele eigenschappen van de apparaat gehandhaafd blijven, zonder zich daardoor te verplichten deze publicatie bij te werken.

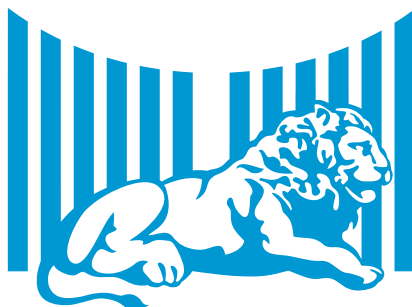

FAAC

FAAC S.p.A.
Via Calari, 10
40069 Zola Predosa (BO) - ITALIA
Tel. 0039.051.61724 - Fax. 0039.051.758518
www.faacgroup.com